

# Matera

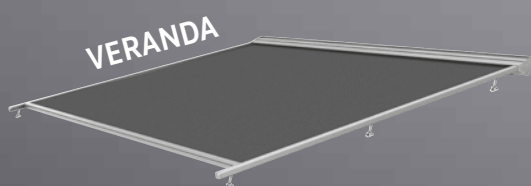

VERANDA

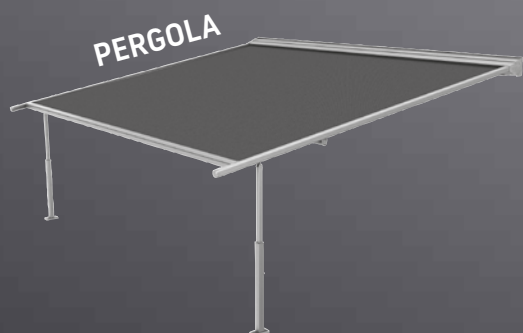

PERGOLA

MATERA, store rétractable sur pieds, un produit combinant un store de terrasse avec une pergola, avec une simplicité de mise en oeuvre .

Les plus grands avantages de ce produit :  
Largeur 600 cm avancée 500 cm, toile zippée pour une tension permanente, structure légère mise en oeuvre simplifiée, ajustement de la pente de 5 à 30 degrés et motorisé. Plusieurs options possibles: Pieds réglables ou fixe, laquage selon nuancier ral en plus des standards et éclairage led.

## Matera Veranda - pose à plat sur toiture – Informations générales

Type:  
**Matera Veranda  
pose à plat sur toiture**

Dimensions maximales:  
**600 x 500 cm**

Commande:  
**électrique**

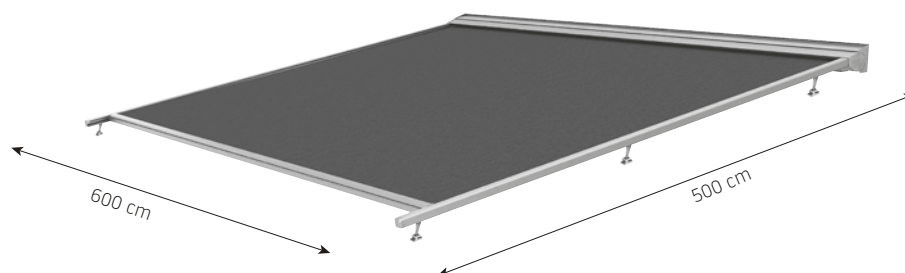

### Fixation murale

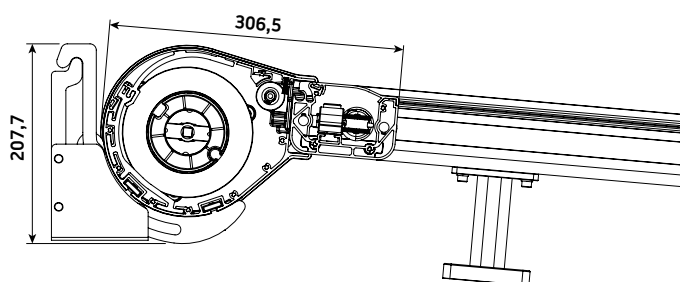

### Support mural

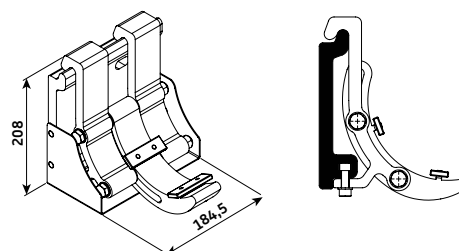

### Montage du store posé (les fixations sont optionnelles)

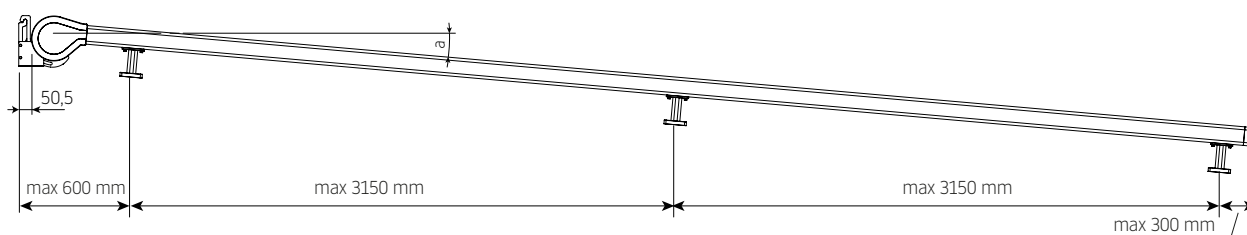

### Éléments de montage

barre de charge

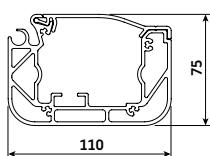

coulisse

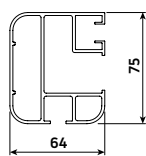

écarteur

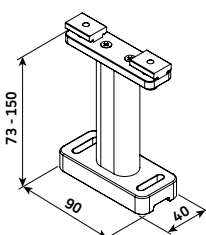

## Matera Veranda - pose avec pieds – Informations générales

Type:  
**Matera Veranda  
pose avec pieds**

Dimensions maximales:  
**600 x 500 cm**

Commande:  
**électrique**

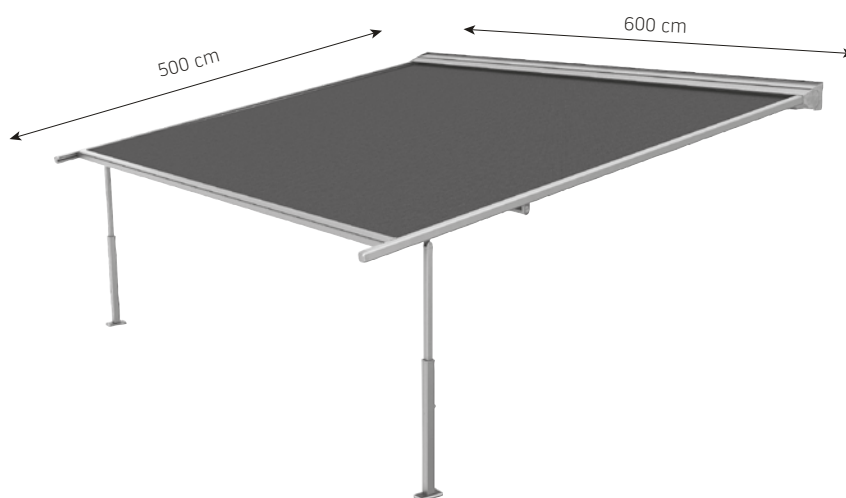

## Support mural

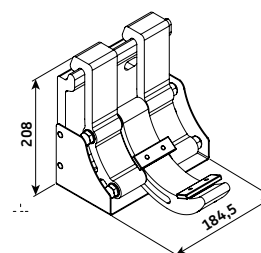
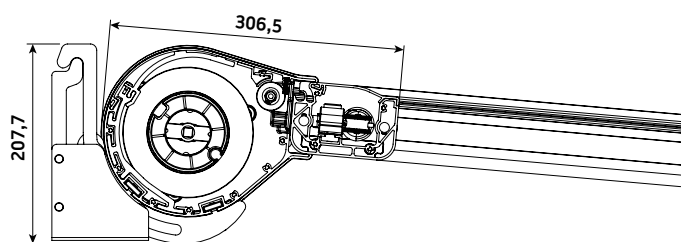

## Éléments de montage

barre de charge

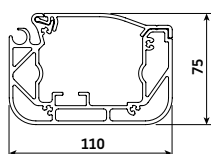

coulisse

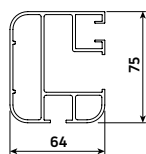

## Poteau

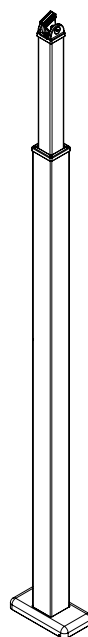

Poteau  
non réglable

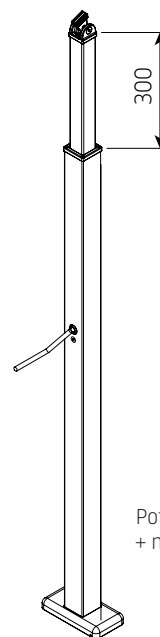

Poteau réglable  
+ manivelle

standard

## Éclairage LED

## Éclairage LEDs avec 1 barre

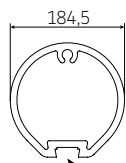

L'espace pour éclairage LED

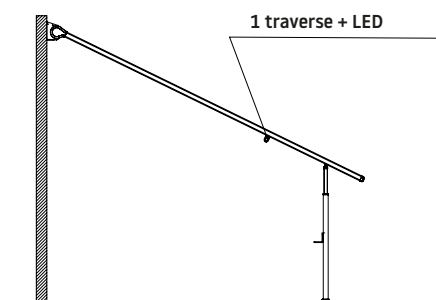

Éclairage LEDs avec 1 barre

Disponible en 3 couleurs standard: (couleur RAL proche de)



RAL 7S16  
Gris anthracite  
(laque structurée)



RAL 9S05  
Noir  
(laque structurée)



RAL 9S07  
Gris Aluminium  
(laque structurée)



01/2020

